

RoHS

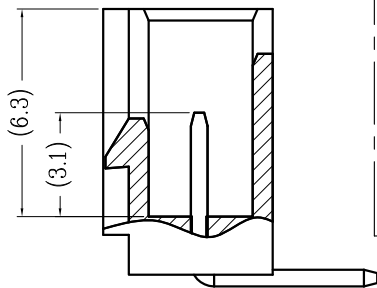

SECTION A-A

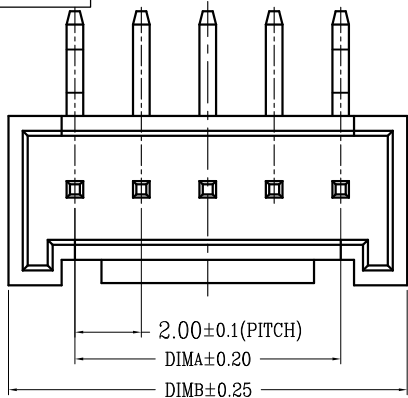
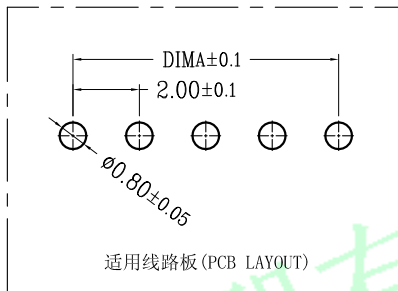

序号	品名	材质
①	HY2.0直针WTB胶芯	PA66 UL94V-0 米色 白色
②	HY2.0弯针WTB端子	铜合金/表面镀锡

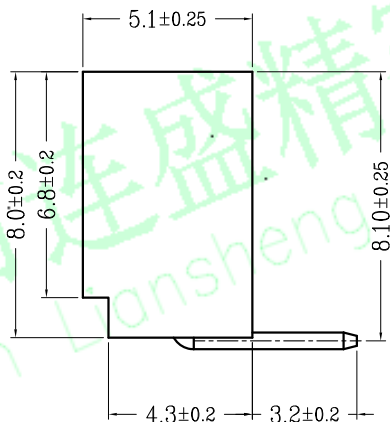
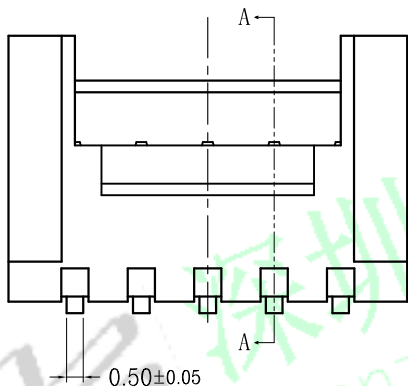
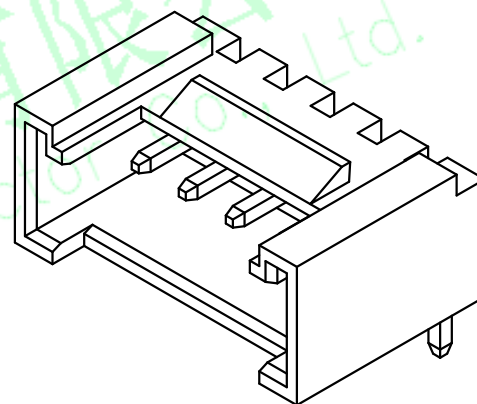

TYPE 1(无K脚)

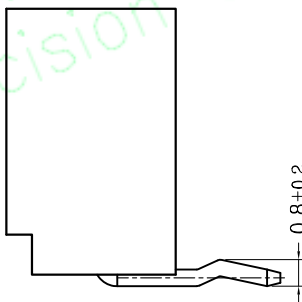

TYPE 2(打K脚)

CKT	A	B	CKT	A	B
2	2.0	6.0	12	22.0	26.0
3	4.0	8.0	13	24.0	28.0
4	6.0	10.0	14	26.0	30.0
5	8.0	12.0	15	28.0	32.0
6	10.0	14.0	16	30.0	34.0
7	12.0	16.0	17	32.0	36.0
8	14.0	18.0	18	34.0	38.0
9	16.0	20.0	19	36.0	40.0
10	18.0	22.0	20	38.0	42.0
11	20.0	24.0			

技术指标(Technical Index):

1. 温度范围(Temperature range): -25° C~+85° C.
2. 额定电压(Rated voltage): 200V, AC.
3. 额定电流(Rated current): 2.0A AC, DC.
4. 接触电阻(Contact resistance): ≤25mΩ .
5. 绝缘电阻(Insulation resistance): ≥1000MΩ.
6. 耐压值(Withstanding voltage): 1000V AC/minute.
7. 产品料号(Product material No.):

OPERATION

DRAW

黄喜俊

SCALE

FIT

X.X ±0.30

±0.30

X.XX ±0.20

±0.20

X.XXX ±0.10

±0.10

Angle ±3'

±3'

DIM TOL

TOL

APPROVE

李双

UNIT

mm

SIZE

A4

SHEET

1/1

PROJ.

◆



深圳市连盛精密连接器有限公司  
Shenzhen Liansheng Precision Connector Co., Ltd.

PART NO.

TITLE:

HY2.0 1\*NP 弯针

REV DATE MODIFICATION DESCRIPTION CHANGE

1

2

3

4

5

6

7

8

9